

SLUDGE / SLURRY
SUBMERSIBLE PUMPS

SLD 3506 - 3508 [37Kw / 50HP]

(60 Hz Standard 460V / 3 Phase / 1200 RPM / 6 Pole)



DAEPUMPS.COM

info@daepumps.com

(760) 821-8112

SLD - 3506 / 3508 - [37Kw / 50HP]

(60 Hz Standard 460V / 3 Phase / 1200 RPM / 6 Pole)

The SLD sludge / slurry range pumps has quality 10 models (6 pole and 8 pole) for a variety of pump duties. Manufactured using only quality materials and the most modern CNC machining processes. With double silicon carbide mechanical seals in an oil bath and a hardened casing for long trouble free operation.



The Pump can handle up to 2.65 sp. gravity of solids & 70% by weight CW. This is subject to d50 values and calculation as per HI recommendation slurry pump selection procedure



Each pump is fitted with a high chromium alloy steel agitator to assist with the reduction of solids to a slurry and which prevents the clogging of the inlet.

FEATURES AND BENEFITS

- Solids to slurry
- Prevents clogging
- High chromium alloy steel - impeller / agitator / wear plate
- Maximum submergence 40 mtr.

CONSTRUCTION

- Dual class winding - IP 68
- 4 Roller Bearing plus 1 angular Thrust Bearing
- Volute casting / Agitator / Impeller / Wear plate (27% chrome) High Wear Resistance
- All other cast parts SG IRON 500 / 7

SPECIAL FEATURES

- Pump Casing / Impeller/Agitator/Wear plate - High Chrome 27%
- Moisture Sensor to protect motor windings
- Temperature sensor to protect the motor
- Lip seal Technology
- Option available - Duplex Steel / SS316L
- Shaft - SS431
- Easy power cable change (30 minutes as max.)

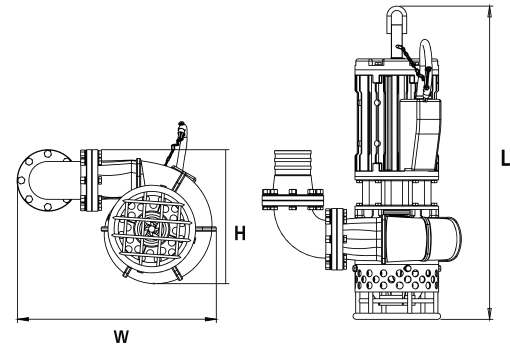

DIMENSIONS (Inches)				
Model	H	L	W	Weight Kg
SLD3506	35	75	40	975
SLD3508	35	75	38	990

